



User guide



Microphone Boom/Turntable Nor265

Nor265 User Guide – December 2004 edition
Im265_1Ed1R2En

Norsonic is a registered trademark of Norsonic AS.

Every effort has been made to supply complete and accurate information. However, Norsonic AS assumes no responsibility for the use of – nor for the consequential damage of the use of – this information and/or the instrumentation described herein. Furthermore Norsonic AS assumes no responsibility for any infringement of the intellectual property rights of third parties, wherever applicable, which could result from such use.

Norsonic AS reserves the right to amend any of the information given in this manual in order to take account of new developments.

If you wish to communicate with us, please feel welcome.
Our address is:

Norsonic AS, P.O. Box 24, N-3421 Lierskogen, Norway
e-mail: info@norsonic.com

Find us on the web: www.norsonic.com

Copyright © Norsonic AS 2002 – 2004
All rights reserved

Contents

1	Introduction.....	5
2	Main application	6
2.1	<i>Microphone boom.....</i>	6
2.1.1	<i>Turntable</i>	7
3	Basic concepts	8
3.1	<i>Definitions of angles – Home position</i>	8
3.2	<i>Speed and acceleration</i>	9
3.3	<i>Sweep.....</i>	10
4	Assembling the Nor265	11
4.1	<i>General.....</i>	11
4.2	<i>Microphone Boom option (Option 1).....</i>	11
4.3	<i>Turntable option (Option 2).....</i>	12
4.3.1	<i>Turntable</i>	12
4.3.2	<i>Chuck.....</i>	13
4.4	<i>Remote operation (Option 3)</i>	13
5	Manual operation.....	14
5.1	<i>Power.....</i>	14
5.2	<i>Front panel</i>	14
5.3	<i>Boom operation.....</i>	15
5.4	<i>Turntable operation</i>	16
6	Control from a PC Program Nor1029.....	17
6.1	<i>General.....</i>	17
6.2	<i>Communication setup.....</i>	17
6.3	<i>Main display.....</i>	18
6.3.1	<i>Local – Remote</i>	19
6.3.2	<i>Go home.....</i>	19
6.3.3	<i>Angle indicator</i>	19
6.3.4	<i>Go to</i>	19
6.3.5	<i>Go relative.....</i>	19
6.3.6	<i>Sweep.....</i>	19
6.3.7	<i>Rotation</i>	20
6.3.8	<i>Stop.....</i>	20
6.3.9	<i>Error messages</i>	20
6.4	<i>Manual control</i>	20
7	Modifying the user interface	21
8	Remote operation.....	23
8.1	<i>Socket.....</i>	23
8.2	<i>Remote commands.....</i>	23
8.2.1	<i>General.....</i>	23
8.2.2	<i>List of commands</i>	25
8.2.3	<i>LP command</i>	27
9	Specification	28
10	Technical design	29
11	Declaration of conformity.....	31

1 Introduction

The Microphone boom/Turntable *Nor265* may be used as a stand-alone device to obtain the spatial average of sound level by moving a measurement microphone back and forth continuously. Main applications are building acoustic measurements (ISO 140-series), measurement of sound absorption in a reverberation room (ISO 354) and determination of sound power levels of sources using sound pressure (ISO 3741). Due to the oscillating back and forth movement a normal microphone cable may be fed through the hollow main shaft without the need for slip rings thereby ensuring very low electrical noise levels are maintained.

The unit may be equipped with a turntable plate or chuck for mounting of different test objects. In this configuration the main application is measurement of directional responses of acoustic transducers like microphones and loudspeakers.

The unit is manually operated by the rotary switch on the front. As delivered from the factory eight of the switch positions (1, 2... 8) corresponds to $\pm 90^\circ$ and $\pm 180^\circ$ sweeps with different sweep speeds. These settings may be redefined by using remote commands if the unit is equipped for remote operation.



Extended control of the device is possible by remote commands from a computer by use of the optional serial interface. This allows accurate control of angular position, speed and acceleration.

The unit is robust and constructed for years of maintenance-free operation.

When a movement or sweep is started, the speed will gradually increase as specified by the acceleration instruction until the selected speed is obtained. The reversed speed-profile is used for deceleration. By specifying a higher value for the acceleration time, even a large or heavy object may be handled.

Nor-265 uses a digital signal processor (DSP) to obtain accurate positioning with simple and robust mechanical design. Accuracy in speed and acceleration are ensured by the use of a precision crystal clock. The design allows a unique combination of specifications suitable for microphone boom applications as well as a general turntable.

The sound emission from the unit is very low, especially when operated at the slower speeds.

2 Main application

2.1 Microphone boom

A number of applications require measurement of the spatial average of the sound pressure level in a room. The average level may be obtained by measuring the level in different positions and then calculation of the average level.

Nor265 may be used for moving the microphone from position to position or the average may be obtained by moving the microphone continuously while measuring the average sound level.

Normally the energetic average is required. This may be obtained directly by use of an integrating-averaging sound level meter set to indicate the time-average sound level L_{eq} . *Nor265* is normally set up to produce an oscillating angular movement backwards and forwards. The time for a complete period may be specified. The integration time for the measurement is normally set to one or a whole number of oscillations.

When delivered, the switch for manual operation is pre-programmed to default sweeps of $\pm 90^\circ$ and $\pm 180^\circ$, respectively. If *Nor265* is equipped for remote operation (option), the user interface may be used to re-programme these settings to obtain other sweeps or to obtain specified positions. The reprogramming of the user interface is most easily done with the MS Windows program *Nor1029* accompanying the remote operation option. Up to eight positions may be selected by the switch on the front. The positions may be programmed by use of the serial interface and will be stored in the internal memory of the device. Alternatively, the switch may be programmed to contain a start angle and a fixed step angle. By the use of remote commands and the accompanying MS Windows program, full control of movements and positions are obtained.

Average sound level

If L_i is the sound pressure level in microphone position $i = 1 \dots N$, the average sound level is calculated by:

$$\tilde{L} = \frac{1}{N} \sum_{i=1}^N 10^{L_i/10}$$



Both the electrical and acoustic noise generated by *Nor265*, even during movement, is very low and allows measurement down to very low levels.

The figure shows a typical set-up for *Nor265* used as a microphone boom. The main body is mounted on a tripod with the microphone mounted at the end of the boom opposite to the counter-weight. A normal microphone cable is fed through the hollow shaft.

2.1.1 Turntable

Nor265 may be used to rotate a device continuously or to move it to a specified angle. The speed and acceleration for a movement may be specified accurately within a wide range. Main application is measurement of directional response of an acoustic transducer. Although the turning moment is limited to prevent damage, the *Nor265* may carry significant loads.



The position and the speed are computer controlled and ensure a smooth and safe movement from one position to another. Remote commands facilitate computer control and fully automatic measurements.

Nor265 may be mounted in any position, even upside down. The main shaft is hollow and allows the entrance of signal cables.

3 Basic concepts

3.1 Definitions of angles – Home position

When the turntable is switched on, the actual position of the table is set as the reference angle 0° . Rotational angles are defined relative to this angle. Positive angles are counter-clockwise as seen from the top of the table. The angles are given in degrees. A full turn corresponds to 360° .

The reference angle may also be set to a hardware defined, fixed angle, called the home position. The home position may be automatically detected by performing a "Go Home" command, either from the user interface or as a remote command. After the start of the command, the table will turn 5 degrees clockwise and then counter-clockwise until the home position is detected. When the home position is detected, this position will be defined as 0° . A light emitting diode (LED) marked 'Home' on the front indicates the status for the home position. The LED will flash until the home position is detected, and thereafter light continuously.

The range for angles is very wide and corresponds to more than 600 000 full rotations in both directions. The figure below shows the range of angles for $\pm 360^\circ$, corresponding to two complete revolutions.

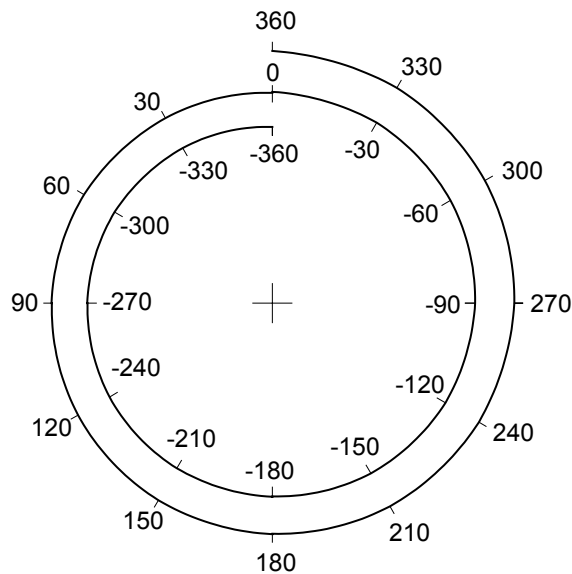

3.2 Speed and acceleration

The speed and acceleration may be set by the user. The speed is specified as time per revolution (second/revolution). The acceleration is specified as the time (second) it takes to obtain the specified speed. The same time is used for deceleration. The default value is 2 seconds. If a large or heavy object is placed on the table, a larger value for acceleration time should be used in order to limit the torque needed. The speed and the angle as the function of time are shown on the figure below.

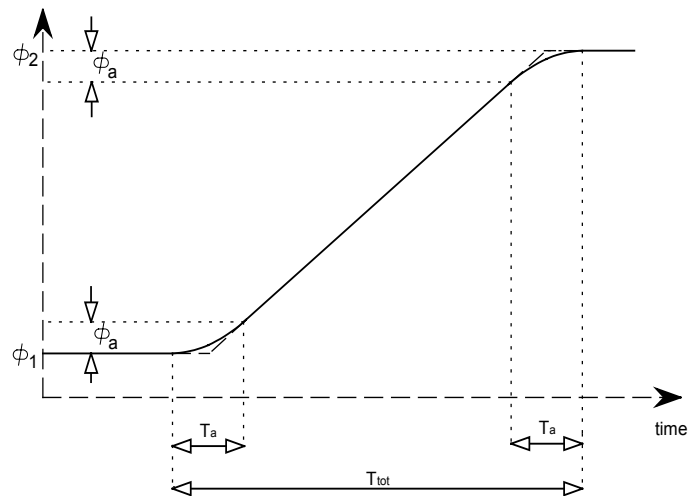
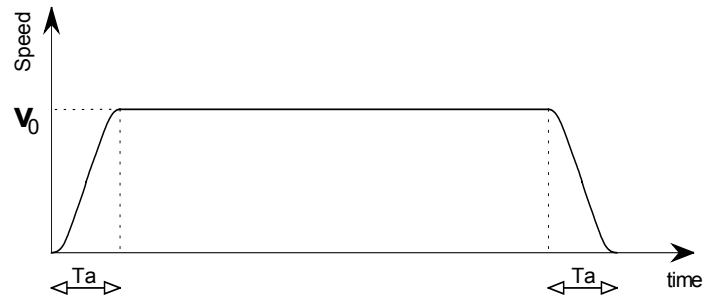

3.3 Sweep

The sweep time is the total time required to perform a complete sweep back and forth including acceleration and deceleration. See figure below for a sweep from angle A to angle B:

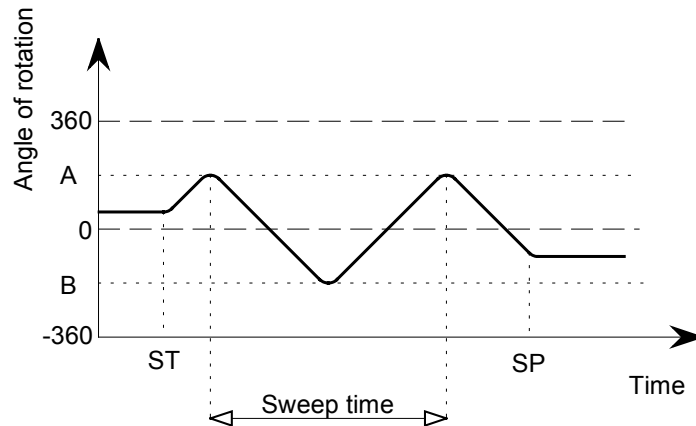

When the sweep is started, the sweep may be described as a consecutive sequence of "Go to A", "Go to B", "Go to A" etc. until the sweep is stopped. The specified acceleration time is used for acceleration and deceleration. When the sweep is started manually, the default value for acceleration time is used.

Vibrations

See section *10 Technical design* of how to reduce resonance-amplified vibrations.

4 Assembling the Nor265

4.1 General



WARNING !

The microphone boom/turntable *Nor265* can be delivered in three different configurations. The main unit consists of the main body with the shaft for mounting either the boom or the turntable. Accessories for microphone boom application are included in *Option 1*, for turntable applications in *Option 2* and access to remote operation and programming of the user interface is gained by ordering *Option 3*.

Nor265 may be delivered with any or all of the options.

The basic *Nor265* consists of:

- Main body (motor) with user interface
- Mains cable
- User guide

The main device is delivered fully assembled. Never open the main body – live voltage inside!

4.2 Microphone Boom option (Option 1)



WARNING !

The kit for microphone boom applications consists of:

- Mounting adapter for telescopic boom
- Telescopic boom
- Counterweight
- Adjustable Microphone clip for ½" microphones
- Mounting hoop (cradle) for tripod with washers and ratchet handles (screws)
- Tripod
- Allen key

Option 1 may be ordered and installed after delivery of main unit.

The tripod is delivered with a separate Instruction manual covering how to adjust the legs etcetera. Note that for this application all legs must be in the inner positions due to the weight of the device. Furthermore, the centre column should be in its lower position.

Remove the centre column from the tripod. Mount the cradle on the column, and then attach the combination cradle/column to main body of *Nor265* by the two ratchet handles and washers as shown on the figure.

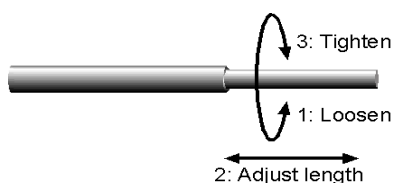

Loosen the outer part of the rod, adjust the length and fasten afterwards.

Mount the main body with the cradle and column on the tripod. Mind the weight of the device!

Locate the mounting adaptor for the boom on the top of the shaft and fasten the screws securely.

Adjust the telescopic boom to a suitable length as shown in the figure. Fasten the boom. Mount the microphone clip on the outer end of the boom.

Mount the counterweight on the end of the boom opposite to the microphone. The counterweight should be adjusted after the microphone and its cable are mounted in order to balance the complete boom assembly around the pivot point. The counterweight is most easily adjusted before you switch the device on and by turning the main body in the cradle so the main turning shaft lies horizontal.

Mount the microphone as requested. You may place the normal Norsonic microphone cable such as *Nor1408* through the hollow main shaft.

4.3 Turntable option (Option 2)

The kit for turntable consists of:

- Turntable with mounting adaptor
- Chuck with mounting adaptor
- Allan key

Option 2 may be ordered and installed after delivery of main unit.

4.3.1 Turntable

Mount the clamp on the main shaft 5 – 6 mm below the end of the shaft to compensate for the thickness of the table plate. Fasten securely with the Allan screws.

Place the table plate on the top of the clamp and fasten the screws.

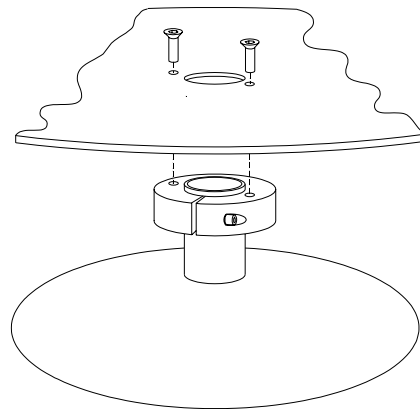

4.3.2 Chuck

When delivered, the chuck is mounted on the mounting adaptor. Place the adaptor on the main shaft as far down as possible and secure the fastening Allen-screws.



4.4 Remote operation (Option 3)

Option 3 has to be ordered before delivery and is installed at the factory. Option 3 consists of:

- RS232 interface
- Cable for RS232 type *Nor1463* (2 m)
- Program *Nor1029*

Installation of the program is described in a leaflet supplied with the program CD.

5 Manual operation

5.1 Power

Nor265 is mains powered and accept mains voltage in the range 90 – 264V AC without any adjustment. The power switch is adjacent to the mains connector. Mains fuses are located behind a cover between the power switch and the mains connector. If replaced, use the same type. See specifications for further information.

5.2 Front panel

The figure below shows the front panel of *Nor265*. Manual operation is controlled by a rotary switch with 10 positions. Position 0 and 10 is reserved for *remote operation* and *go home* commands respectively. The other 8 positions may be programmed to have different functions (Option for remote control needed), but are set by default to provide the following actions:

1. Stop
2. Sweep $\pm 180^\circ$, sweep time 120 sec
3. Sweep $\pm 180^\circ$, sweep time 60 sec
4. Sweep $\pm 180^\circ$, sweep time 30 sec
5. Sweep $\pm 90^\circ$, sweep time 15 sec
6. Sweep $\pm 90^\circ$, sweep time 30 sec
7. Sweep $\pm 90^\circ$, sweep time 60 sec
8. Stop

When the *Nor265* is switched on, the actual angular position will be reference 0° , and the sweep is relative to this start angle. Thus the sweep will be $\pm 90^\circ$ from this start angle, or $\pm 180^\circ$ dependent on the sweep selected. However, if the switch is set to "Go home" before any sweep is selected, the reference 0° will be a fixed position on the body of *Nor265*.

The LED marked "Home" will be flashing after power on and remain flashing until a "Go home" command has been activated. After the start of the command, the table will turn 5 degrees clockwise and then counter-clockwise until the home position is detected. *Let the 'Go home' operation finish before you operate the switch for other actions.*

The LED marked 'busy' will light while the motor is running. The LED marked 'error' will indicate a faulty condition, such as specifying invalid remote commands.

Note that position 1 – 8 are programmable and may be set to other functions such as going to a fixed position, e.g. 135° or step 10° clockwise. See section 7 *Modifying the user interface* for further information.

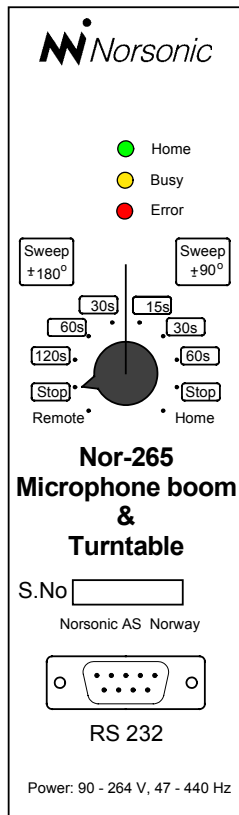

5.3 Boom operation

Mount *Nor265* as described in section 4 *Assembling the Nor265*. Normally the device is mounted in the tripod when used as a microphone boom.

Mount the boom with counterweight. Mount the measurement microphone in the end of the rod. An ordinary microphone cable like Nor1408 is normally used between the microphone preamplifier and the sound level meter. The cable may be fed through the hollow shaft as shown on the figure

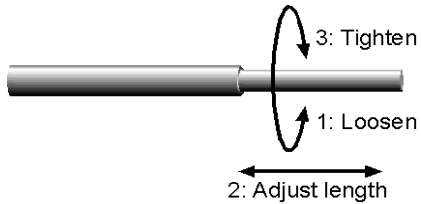

Loosen the outer part of the rod, adjust the length and fasten afterwards.

Adjust the length of the rod in accordance with your requirements. The rod is telescopic with two parts. Loosen the outer part where the microphone is mounted by turning it anti-clockwise as seen from the microphone end. Pull it out to the required length, and fasten it by turning it clockwise.



A counterweight has to be placed opposite to the microphone to balance the rod about the turning point. We recommend doing this before the power is switched on in order to allow the shaft to rotate freely. Turn the body so the main shaft is horizontal, and adjust the position of the counterweight until the rod with the microphone is in balance as shown on the figure below.

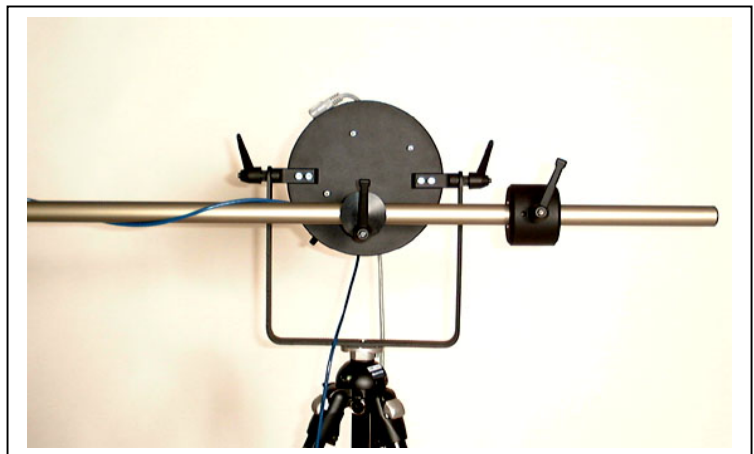

Switch on the device. If you want to use the fixed reference angle, turn the switch to the position "Go home". *Wait until the LED marked "Go home" lights continuously.*

Select the appropriate sweep range and time by turning the rotary switch to the corresponding position as indicated on the front panel. Note that the operation for the various positions may be redefined. See section 7 *Modifying the user interface* for further information.

The torque for the device is limited and the device will not be harmed if its movement is blocked. You may even turn the device by hand to obtain a suitable reference angle. However, any calibrated home position will then be lost.

The motor will try to keep the boom in the required position with a torque similar to a spring force. The inertia of the boom and this spring force will have a distinct resonance frequency. Adjust the

combination of the length of the boom and the speed to keep away from this resonance which otherwise may enhance the small vibrations from the motor.

5.4 Turntable operation



Although the *Nor265* may be manually operated by the switch on the front remote operation is normally required when the device is operated as a turntable. Typical applications are the measurement of the directional response of a microphone or a loudspeaker. The table may be set up to rotate continuously and the angular position may be logged, or the table may be set up to rotate in small steps.

The torque of the device is limited in order not to harm the user or devices placed on or around the turntable. Still it can carry considerable loads in any direction. Note therefore that the loads have to be balanced around the turning axis. If a large or heavy object is placed on the table, increase the acceleration time in order to reduce the torque needed to produce the required acceleration.

The table will not be harmed by blocking its movement. The table may be turned by hand, even when powered, to obtain a suitable reference angle.

Since the angle may be controlled very accurately and even specified as a number of rotations (e.g. specifying 3500° means about 9,7 revolutions) *Nor265* may be used for a wide variety of positioning applications. Sketches of applications for horizontal and vertical movement are shown below.

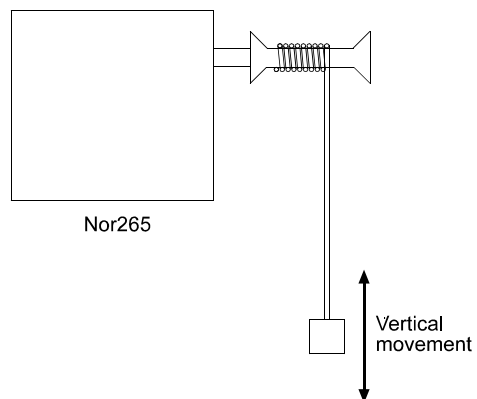
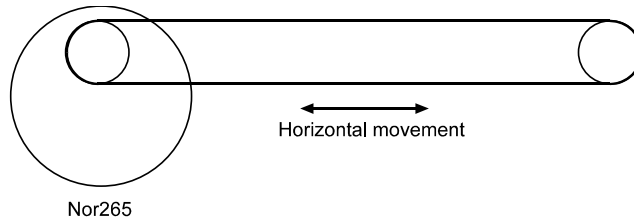

6 Control from a PC Program Nor1029

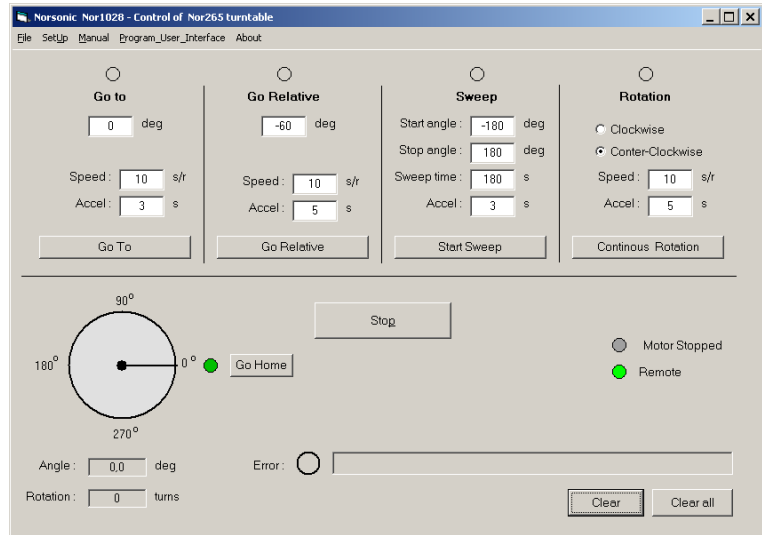
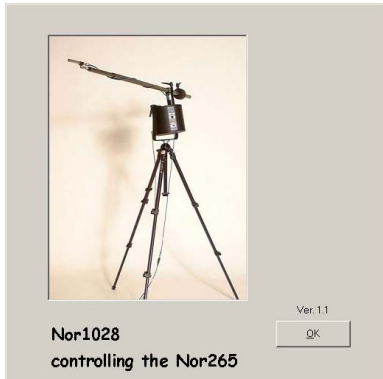

6.1 General

If *Nor265* is installed with Option 3 for remote operation, it may be controlled by the accompanying MS-Windows program *Nor1029*. See the leaflet attached to the program CD for instruction of how to install the program on your PC.

When opened, the main display as shown in the figure above will be displayed. The program uses the standard remote commands for communication. See section **8.2.2 List of commands** for further details. This list also contains full information about the valid range for all parameters.

After installation of the software, you will get a new program group on the start menu.

When you start the program, *Nor1029* tries to set up the *Nor265* with the default settings from the virtual panel of the program. If this communication does not start automatically within 10 seconds, you have to set up the communication by selecting *Set Up* on the menu line.

6.2 Communication setup

Select *Set Up* from the main display to display the following screen:

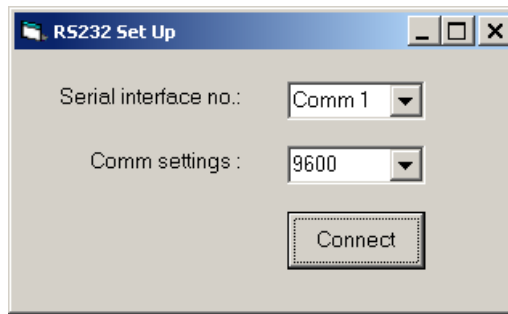

Select the appropriate communication port and speed. Note that the default speed (Comm. Setting) in Nor265 is 9600 baud.

Press **Connect** to open the port.

When these settings are finished, you may return to the main display.

The program is most conveniently operated with the combination of the PC-mouse and the keyboard. Point on the field to enter the numeric values, left-click to place the cursor and type in the number or string as requested. Press the virtual buttons by pointing and left-clicking with the mouse.

6.3 Main display

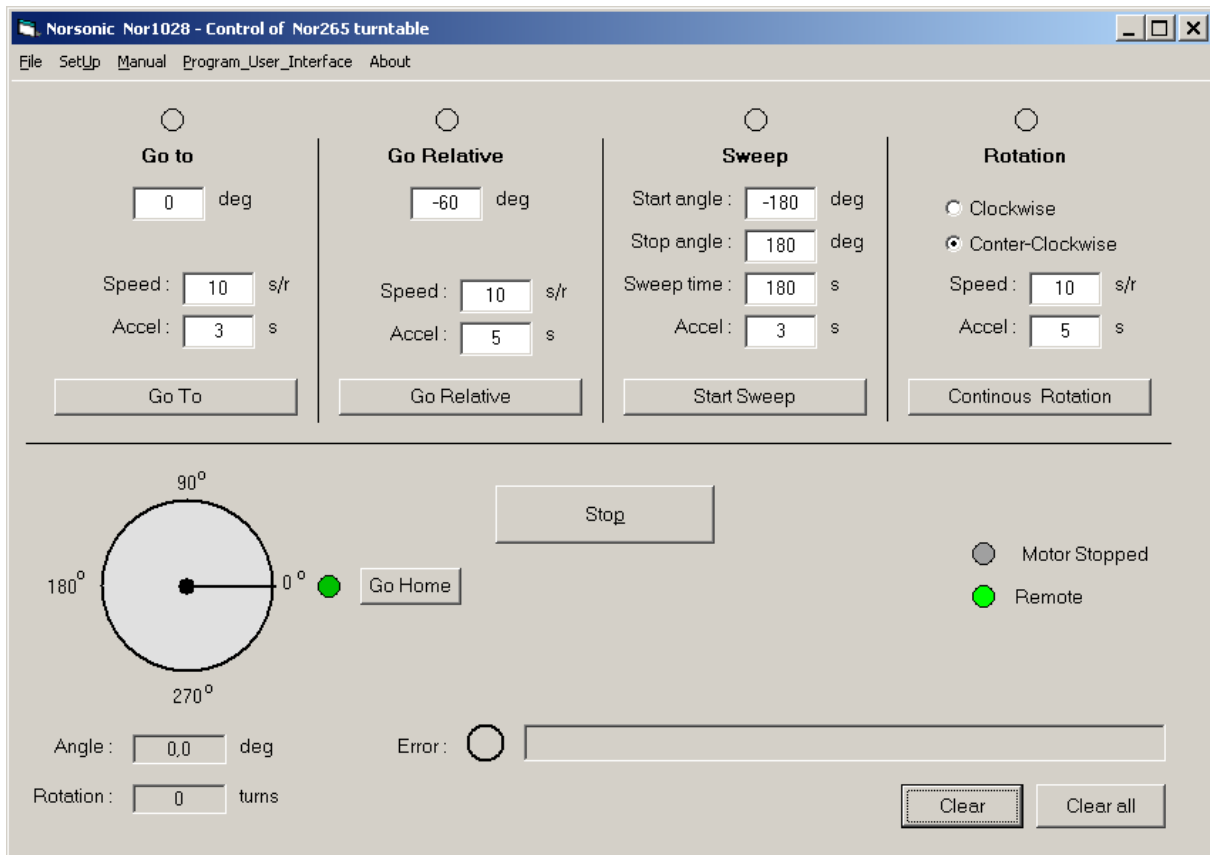

6.3.1 Local – Remote

The Microphone boom/ turntable must be in remote operation mode in order to be controlled from the program. Turn the switch on the front of *Nor265* to position ‘Remote’. If the communication works correctly, the local/remote-indicator on the virtual front panel will indicate remote.

6.3.2 Go home

If you want to refer angles to the fixed reference for the table, you must perform a “Go home” command after each power up. The indicator adjacent to the button will change from flashing to being continuously illuminated. While the turntable is running, the indicator marked as motor running will be on. After a successful “Go home” command, the angle indicator will be at 0°.

6.3.3 Angle indicator

The actual angle is displayed on the lower left side of the virtual panel. The angle is displayed graphically and as a numeric value. Angles outside $\pm 360^\circ$ will be displayed as a combination of angles inside this range and a number of turns.

Note that the logging of the actual angle is done at a relative low speed. The movement of the angle indicator will therefore be stepwise even if the movement on the table is smooth.

6.3.4 Go to

Specify the angle to which you want to go. Note that the angle may correspond to a number of revolutions. The maximum angles are $\pm 241592002^\circ$ which corresponds to more than 600 000 revolutions.

The speed is always specified as time in seconds needed for a full 360° rotation if the turntable runs continuously.

The acceleration (Accel) is the time to obtain the specified speed. The actual acceleration will therefore depend on the speed selected.

Press the virtual “Go To” button to start the movement. The indicator above the fields will light until the final position is reached.

6.3.5 Go relative

Go relative means that the present angle will be modified with the specified step. If the current position is 125° and you specify ‘Go relative -3°’, the new position will be 122° . Speed and acceleration are specified as for the “Go To” command.

“Go Relative” is a convenient way to move manually in specified steps to obtain a full rotation.

6.3.6 Sweep

When the sweep is started, it will move from the current position to the start angle. Then the sweep will be performed as a back and forth movement between the specified start and the stop angle. The sweep will continue until it is stopped.

The specified sweep time is the time for a complete back and forth movement and includes the time for acceleration and deceleration.

Note that a sweep may contain a number of rotations if so specified.

6.3.7 Rotation

The mode starts an infinitely long continuous rotation either clockwise or counter-clockwise.

6.3.8 Stop

The stop-button stops an ongoing movement. The selected acceleration time is used for the deceleration. The operation is mainly used for terminating a sweep or a continuous rotation.

6.3.9 Error messages

If the turntable *Nor265* receives a command outside the valid range, or a selected combination is forbidden, the turntable will return an error message. Such a message will be displayed in clear text in the error message field. The message may be cleared by operation of the virtual clear-buttons.

6.4 Manual control

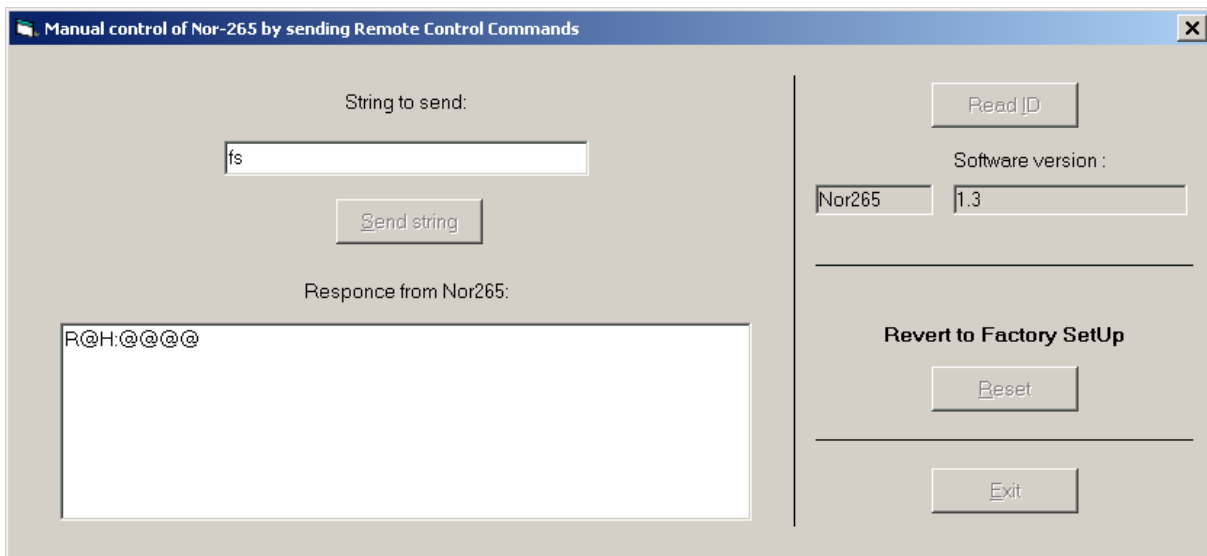

By selecting the manual control from the program *Nor1029*, you may send the remote commands to the table *Nor265* as strings. This gives you full access to all remote commands. See the figure above for the layout of the user panel. You specify the string to be sent in the upper field. The response from the turntable is displayed in the lower field.

The different remote commands are described in section **8.2 Remote commands**

You may use the virtual button **Read ID** to see the software version used in the *Nor265*. You may also use this button for verification of the communication between the PC and turntable.

The panel has a reset button for setting all parameters in the turntable to the values specified as default from the factory.

7 Modifying the user interface

The user interface may be modified by remote commands if *Nor265* is equipped with the option for remote operation. This means that position 1 to 8 of the rotational switch may be programmed to any of the normal states of operation:

- stop movement
- go to a specified angle position
- go relative from current position
- rotate continuously with specified speed and direction
- sweep between two specified sweep limits

As an example, if you program switch position **1** to "stop" and position **2** to "go relative 10° ", the boom will step 10° counter-clockwise each time the switch is moved from position **1** to **2**. The current value while programming will be used for the speed and acceleration time.

Note that you are not allowed to redefine the action for switch positions **0** *Remote* and **9** *Go home*.

The programming of the user interface is most easily done from Program *Nor1029*. See figure below for the screen copy.

Programming the Nor265 front panel switch

First: Select which switch position to program

Position 1 Position 2 Position 3 Position 4 Position 5 Position 6 Position 7 Position 8

Second: Select the function and parameters to activate on this switch selection

Go to Go Relative Sweep Rotation Stop

deg deg Start angle: deg Clockwise
 s/r s/r Stop angle: deg Conter-Clockwise
 s s Sweep time: s Speed: s/r
 s s Accel: s Accel: s

Third: Push the Program button to transfer this set up to the Nor265

Current set up:

```

1,0
2,1,2.00,120.00,180.00,-180.00
3,1,2.00,60.00,180.00,-180.00
4,1,2.00,30.00,180.00,-180.00
5,1,2.00,15.00,90.00,-90.00
6,1,2.00,30.00,90.00,-90.00
7,1,2.00,60.00,90.00,-90.00
8,0

```

Fourth: Inspect the Error indication:

If you want to get the factory default settings back in the Nor265, go to the Manual Set up screen and use the Revert to Factory Set Up selection.

Alternatively, use the remote commands directly as described in section **8 Remote operation**.

Start the program *Nor1029* and select “Program user interface” in the menu on the main screen. The screen for programming will be displayed as shown above.

Select the switch position to be programmed (1 – 8) from the first row.

Select the wanted function from the second row and enter all parameters in the appropriate field below the selected function.

Press the button on the third row.

If you want a list of the current setting or want to verify that the wanted changes has been made, press the button

. A list of the setting for switch position 1 to 8 will appear. See description in section **8.2.3 LP command** for format of the listing.

8 Remote operation

The turntable may be remotely controlled by a RS 232 serial interface, (default 9600 baud) with hardware handshake. Commands other than reading status are ignored if the user operation switch is not set to remote.

8.1 Socket

Socket for remote command: 9 pin D-sub male, see figure.

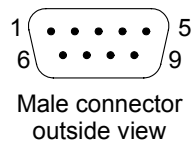

Pin no	Signal	Dir
1		
2	RD	In
3	TD	Out
4		
5	GND	
6		
7	RTS	Out
8	CTS	In
9		
Housing	GND	

If the computer or other controlling device has a 9-pin serial port with a male connector, use a null modem cable like Nor1463 for the connection.

8.2 Remote commands

8.2.1 General

Remote operation is done most easily by using the accompanying MS-Windows program *Nor1029*. This allows easy control of *Nor265* from WS-Windows based PC. The program may also be used for programming the operation of the rotary switch on the front of *Nor265*. If you are using the program, you may skip most of the information in this section. However, if you want the operation of *Nor265* to be smoothly integrated into your own program, you need the detailed information in this section.

The communication is based on RS232, which allows long cables between the computer and the turntable. Note that the maximum length of cables will depend on the selected baudrate, the type of cable (capacitance) and the device controlling the turntable. It therefore not possible to specify the maximum length, but up to 100 m has been used successfully when combined with the lowest baudrate of 9600.

Default baudrate is 9600, but may be set to other vales. If your computer does not have an RS232 serial interface, we recommend connecting the turntable to the USB-port by using a commercially available USB/RS232 adaptor.

If a command contains a parameter, there must be a space between the command and the parameter. When a numeric value is entered for the parameter, both comma "," and dot "." may be used as decimal symbol. The number may be entered with any number of decimals after the decimal point. All commands must be ended with one or more terminators. The terminator may be: carriage return <CR>, line feed <LF> and semicolon " ; ".

When a numeric value is returned from *Nor265*, a dot "." is always used as decimal symbol.

The following table contains the remote commands

8.2.2 List of commands

Instruction	Command	Parameter	Notes
Reset	IR	None	Generates a hardware reset
Fetch Status	FS	None	Transfer format: x y z : w1 w2 w3 w4<CR><LF> x = L : Local operation (Set by user interface) x = R : Remote operation (Set by user interface) y = B : Busy – motor running y = @ : Finished/Ready z = H : Home detected z = U : uncalibrated angle reference (home not detected) w = A : Angle parameter out of range w = S : Speed parameter out of range w = T : Sweep time parameter out of range w = C : Acceleration parameter out of range w = L : Sweep limit parameter out of range w = R : Relative angle parameter out of range w = E : Unknown command w = P : Missing space before parameter w = W : Sweep time too short w = X : Command is not legal while in local operation w = N : Home detector not found w = I : Illegal command during home process w = O : Illegal position for PP command w = B : Baud rate out of range w = @ : OK – no error detected w1, ... w4 means last four errors detected since last "FS-command"
Instrument identification	ID	None	Nor265<CR><LF>
Software version	SW	None	Read out of string reporting instrument program version. Format: "string"<CR><LF>
Go home	GH	None	Find the fixed home position. The position is set to the reference angle 0°.
Go to	GT x	$-241592002.0 \leq x \leq 241592002.0$	Go to the specified position (degrees) with the acceleration and speed as set by the TA- and TR-instruction, respectively. Format for x: ±dd.dd

Instruction	Command	Parameter	Notes
Speed	TR x	$5 \leq x \leq 3600$	Sets the speed for movement. The speed is indicated as time in seconds per revolution. Does not apply to sweep!
Acceleration	TA x	$1 \leq x \leq 30$	Sets the time for acceleration and deceleration. Default value is 2. See description in the text.
Sweep time	TT x	$10 \leq x \leq 3600$	Set the time for a complete sweep (back and forth) in seconds.
Start sweep	ST	None	Starts a continuous sweep as set by TT/SA/SB/TA-instruction.
Stop	SP	None	Stop an ongoing sweep or continuous movement.
Sweep limit A	SA x	$-360.0 \leq x \leq 360.0$	Set the first sweep limit in degrees Format for x: ±ddd.d
Sweep limit B	SB x	$-360.0 \leq x \leq 360.0$	Set the second sweep limit in degrees Format for x: ±ddd.d
Go relative	GR x	$-3600.0 \leq x \leq 3600.0$	Go to an angle relative to the start angle with the acceleration and speed as set by the TA- and TR-instruction, respectively. Format for x: ±dddd.d
Go continuous positive direction	CP	None	The table is turned continuously in the positive direction with the speed set by the TR-instruction.
Go continuous negative direction	CN	None	The table is turned continuously in the negative direction with the speed set by the TR-instruction.
Set default set-up	MR	None	Set parameters, as speed, acceleration, switch positions and baud rate, to default values
Get angle	AN	None	Transfers angle as: ±ddd.ddddd
Program switch positions x	PP x	$1 \leq x \leq 8$	Program the switch position x to the last command done with the current parameters. (ST,SP,CN,CP,GT or GR)
List setup for switch positions	LP		See explanation in 8.2.3 below the table
List current parameters set up by IO commands.	LR		Transfer parameters as follows a.aa ±b.bb, ±c.cc d.dd e.ee where a.aa is acceleration, b.bb and c.cc is sweep limit A and B, d.dd is sweep time and e.ee is speed.
Set baud rate	BR	0=9600, 1=19200, 2=38400, 3=57600, 4=115200	Default is 9600.
Prepare for SW download	LSLoadSoftware		After this command, new SW can be loaded with a special PC program. Intended for use by Norsonic only.

Instruction	Command	Parameter	Notes
Program Flash memory with running SW.	BFBurnFlash		Intended for use by Norsonic only.
Display memory	DM x		For debugging by Norsonic only.

8.2.3 LP command

When the *LP command* is executed, a list of the parameters associated with position 1 to 8 for the front panel switch is returned: The list has the following format where the first number in each line corresponds to the switch position number.

```

1, <Type>, <Info> <CR> <LF>
2, <Type>, <Info> <CR> <LF>
3, <Type>, <Info> <CR> <LF>
4, <Type>, <Info> <CR> <LF>
5, <Type>, <Info> <CR> <LF>
6, <Type>, <Info> <CR> <LF>
7, <Type>, <Info> <CR> <LF>
8, <Type>, <Info> <CR> <LF>

```

The <Type> of operation is indicated by a number between 0 and 5. The <Info> will contain a list of parameters relevant for the Type. The designators for the parameters correspond to the commands in the list for remote commands. Each parameter is separated by a comma symbol ",".

<Type>	Type	Parameters in <Info> field			
0	Stop [SP]				
1	Sweep [ST]	TA	TT	SA	SB
2	Go to [GT]	TA	TR	GT	
3	Go relative [GR]	TA	TR	GR	
4	Continuous positive rotation [CP]	TA	TR		
5	Continuous negative rotation [CN]	TA	TR		

9 Specification

Size – main body:	Diameter 202 mm, Height: 171 mm
Weight – main body:	6 kg
Mounting:	Tripod which allows inclined traverse plane Diameter of tripod mounting stud: 3/8"
Main axle dimension:	Outer diameter: 30 mm Inner diameter: > 22 mm
Units to be mounted on turn axle:	Microphone boom (option 1) Turn table plate – diameter: 300 mm (option 2) Chuck (2 – 13 mm) (option 2)
Boom radius:	0,8 – 2 m (continuously adjustable)
Rotation angle:	-241592002° to +241592002° (more than 600.000 revolutions) May also be set to rotate continuously at a specified direction and speed.
Resolution:	0.01°
Angle accuracy (no torque):	Better than 0.8°. Typical better than 0.05° if moved in same direction.
Max load (any direction):	500 N
Max torque loading:	2 Nm
Typical error from loading torque:	0.3 deg/Nm
Power supply:	90 – 264V AC / 47 – 440 Hz
Fuses:	2,5 A slow blow (IEC 60127)
Remote operation:	RS-232 interface:9600 – 115200 baud (option 3)
Noise emission	Less than 10 dB A (at rest) Typical noise A-weighted: 40 dB at 5 sec/rev 27 dB at 10 sec/rev 23 dB at 20 sec/rev The noise is measured in an anechoic chamber with the moving microphone placed on the boom – 1,5 m from the main body.
Temperature range	-10 to 50 °C
Humidity	0 – 90 %RH

10 Technical design

The figure below shows a block-diagram of the microphone boom/turntable *Nor265*.

The motor is a stepper motor designed for continuous movement (micro-stepping). A digital signal processor controls the position of the motor shaft directly with a very high resolution. Since the systems apply no feedback, the system will never generate the type of noise often found in feedback system due to play resulting from wear in the drive system.

The motor is powered all the time, even at rest, and will therefore need no braking action.

The benefits of the design include simple and robust mechanical parts. No gearbox, only a timing belt is needed between the motor and the main shaft. The stepper motor is robust without any commutator or brushes. Blocking the movement will not harm the motor. The table may be turned by hand, even when powered, to obtain a suitable reference angle. Due to the design, the torque will partly depend on the actual angle for the motor. This modulation of the torque may under certain circumstances create small vibrations that may be enhanced by a resonance in the device placed on the table.

The torque of the device is limited in order not to harm the user or devices placed on or around the turntable. Still it can carry considerable loads in any direction. Note therefore that the loads have to be balanced around the turning axis. If a large or heavy object is placed on the table, increase the acceleration time in order to reduce the torque needed for the acceleration.

The motor will try to keep the boom in the wanted position with a torque similar to that from a spring force. The combination of this force and the inertia of the moving mass will have a distinct resonance frequency. Adjust the speed to keep away from this resonance which otherwise may enhance the small vibrations from the motor.

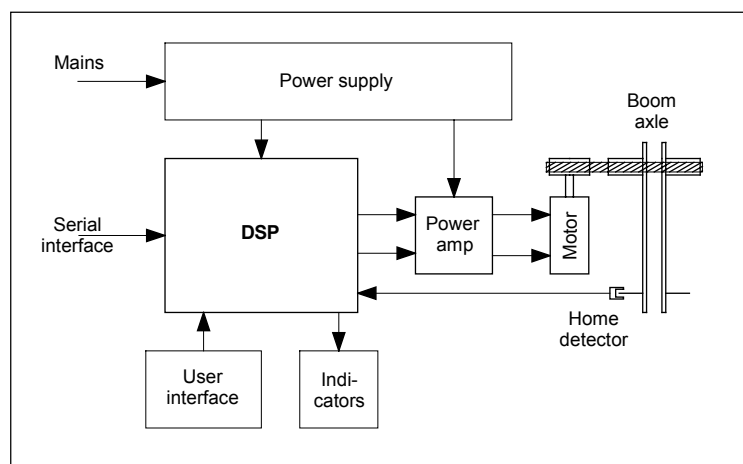

11 Declaration of conformity

We, Norsonic AS, Gunnarsbråtan 2, Tranby, Norway, declare under our sole responsibility that the product:

Microphone boom/Turntable Nor265

to which this declaration relates, is in conformity with the following standards or other normative documents:

EMC	EN 61000-6-1 EN 61000-6-3
Safety	EN 61010-1 EU - Machine directive

This product has been manufactured in compliance with the provisions of the relevant internal Norsonic product standards. All our products are tested individually before they leave the factory. Calibrated equipment – traceable to national and international standards – has been used to carry out these tests.

This Declaration of Conformity does not affect our warranty obligations.

Tranby, December 2002

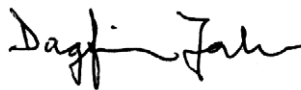

Dagfinn Jahr
Quality Manager

The declaration of conformity is given according to EN 45014 and ISO/IEC Guide 22.

Norsonic AS, P.O. Box 24, N-3221 Lierskogen, Norway



P.O.Box 24
N-Lierskogen
Norway

www.norsonic.com